



DPSIR schema
and
numerical models
in
Air Quality management

July 8th 2013
CEFAP
Codroipo

ARPA FVG – CRMA
Agenzia Regionale per la Protezione dell’Ambiente del Friuli Venezia Giulia
Centro Regionale di Modellistica Ambientale
crma@arpa.fvg.it



Introduction: general



What we are talking of...



We are talking of:

ATMOSPHERIC POLLUTION

AMBIENT-AIR QUALITY

*(not of carbon dioxide and climatic changes;
not of indoor air pollution, nor of air quality in working environments; etc.)*

In particular...

of using **mathematical models** to **describe** and **predict** these phenomena

What's the goal?

Protecting health, ecosystems and economy



Introduction: general



... using mathematical models to describe and predict ATMOSFERIC POLLUTION

Why should YOU be particularly interested in it?

Because ARPA requires it in Environmental Impact Assessment Studies!



DPSIR framework



Introduction: DPSIR



D.P.S.I.R. schema

to place the following elements and **relations** between them:

1. pollution **sources** (emissions)
2. **metheorology**
3. **quality of the air** we breathe
4. its **effects** on health, ecosystems and economy
5. **Legislation** in this matter and authorization processes

*DPSIR is a “conceptual” and “qualitative” schema:
it becomes “quantitative” by means of mathematical models*

D.P.S.I.R.

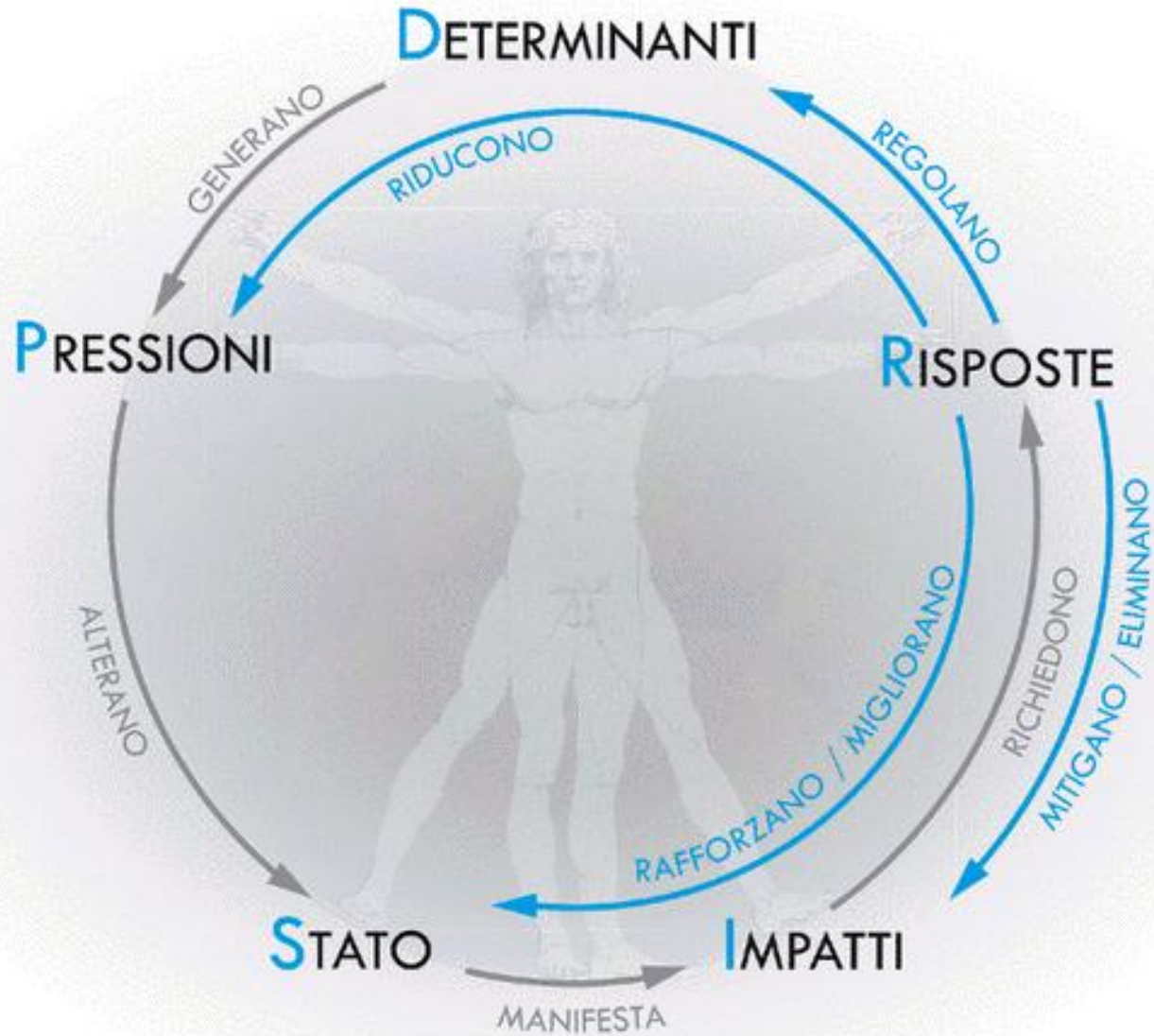

D.P.S.I.R.

DETERMINANTI

DRIVING FORCES:
"indirect" causes of atmospheric pollution

- Es:*
- 1. ~1,500,000 people in our Region
 - 2. morphology, meteorology and climate of Po valley
 - 3. mean per capita energy requirement
 - 4. quantity of raw material used by a factory
 - ...

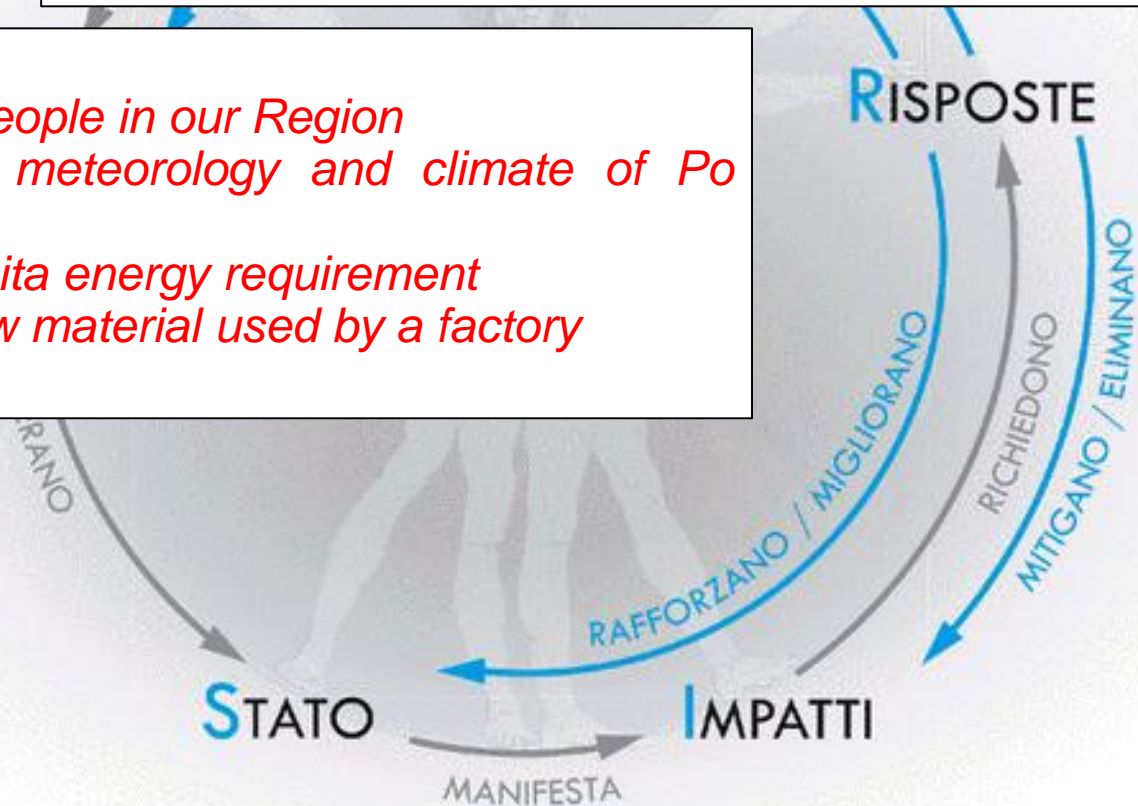

D.P.S.I.R.

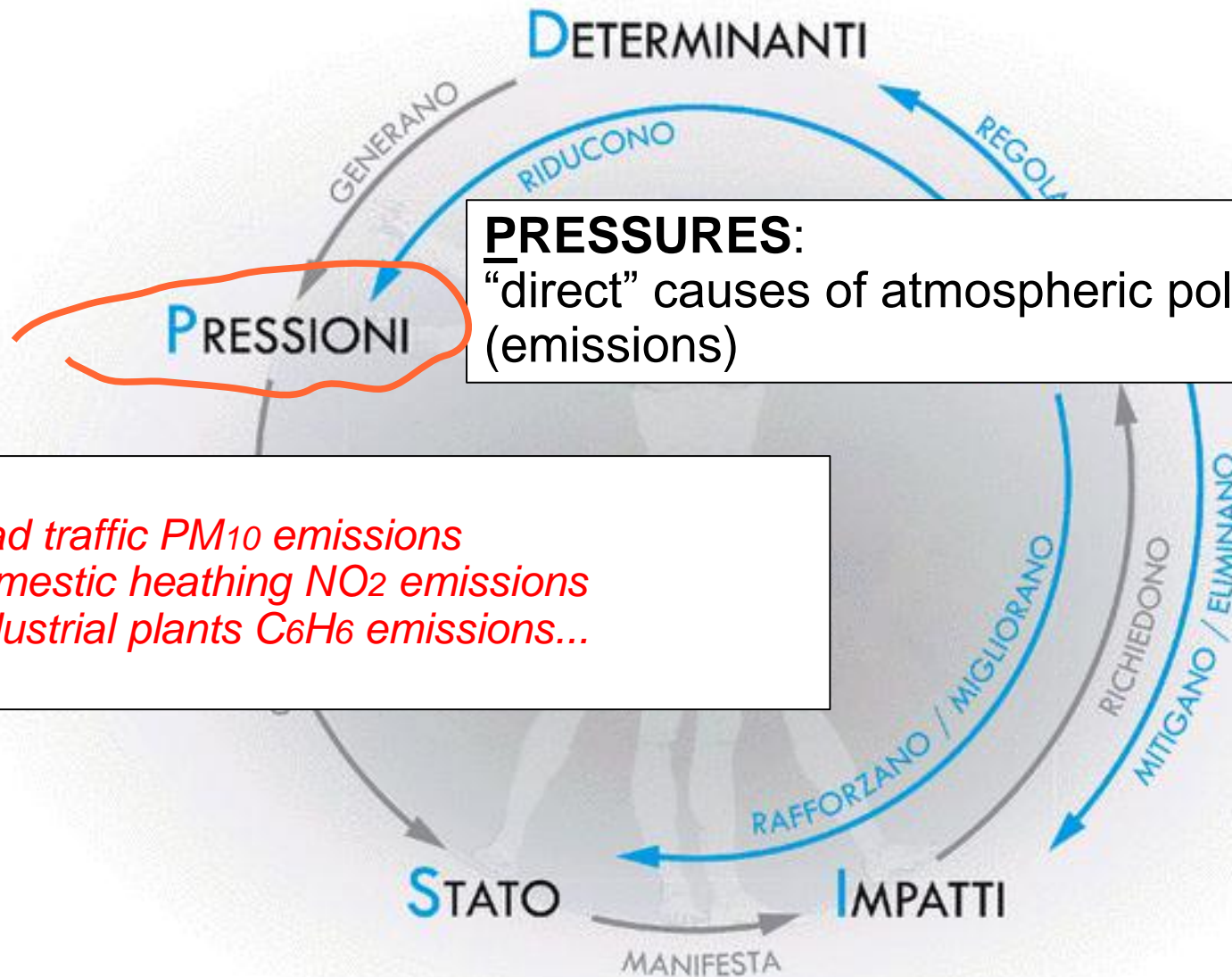

PRESSURES:

“direct” causes of atmospheric pollution (emissions)

- Es:**
1. road traffic PM₁₀ emissions
 2. domestic heating NO₂ emissions
 3. industrial plants C₆H₆ emissions...
 - ...



in Air Quality terms...



D.P.S.I.R.

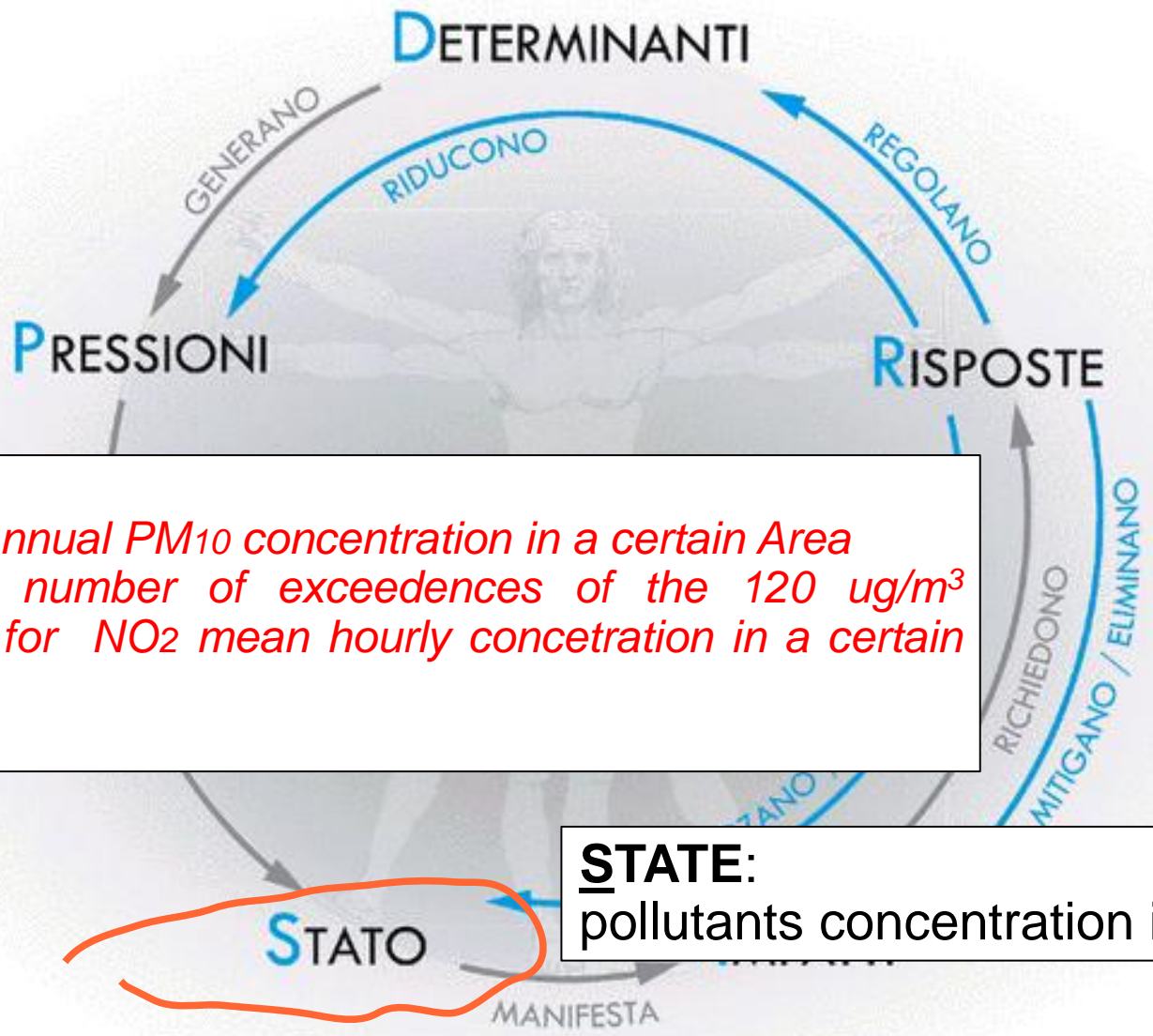

Es:

- 1. mean annual PM_{10} concentration in a certain Area
- 2. yearly number of exceedences of the $120 \mu g/m^3$ threshold for NO_2 mean hourly concentration in a certain Area
- ...

STATE:
pollutants concentration in air

D.P.S.I.R.

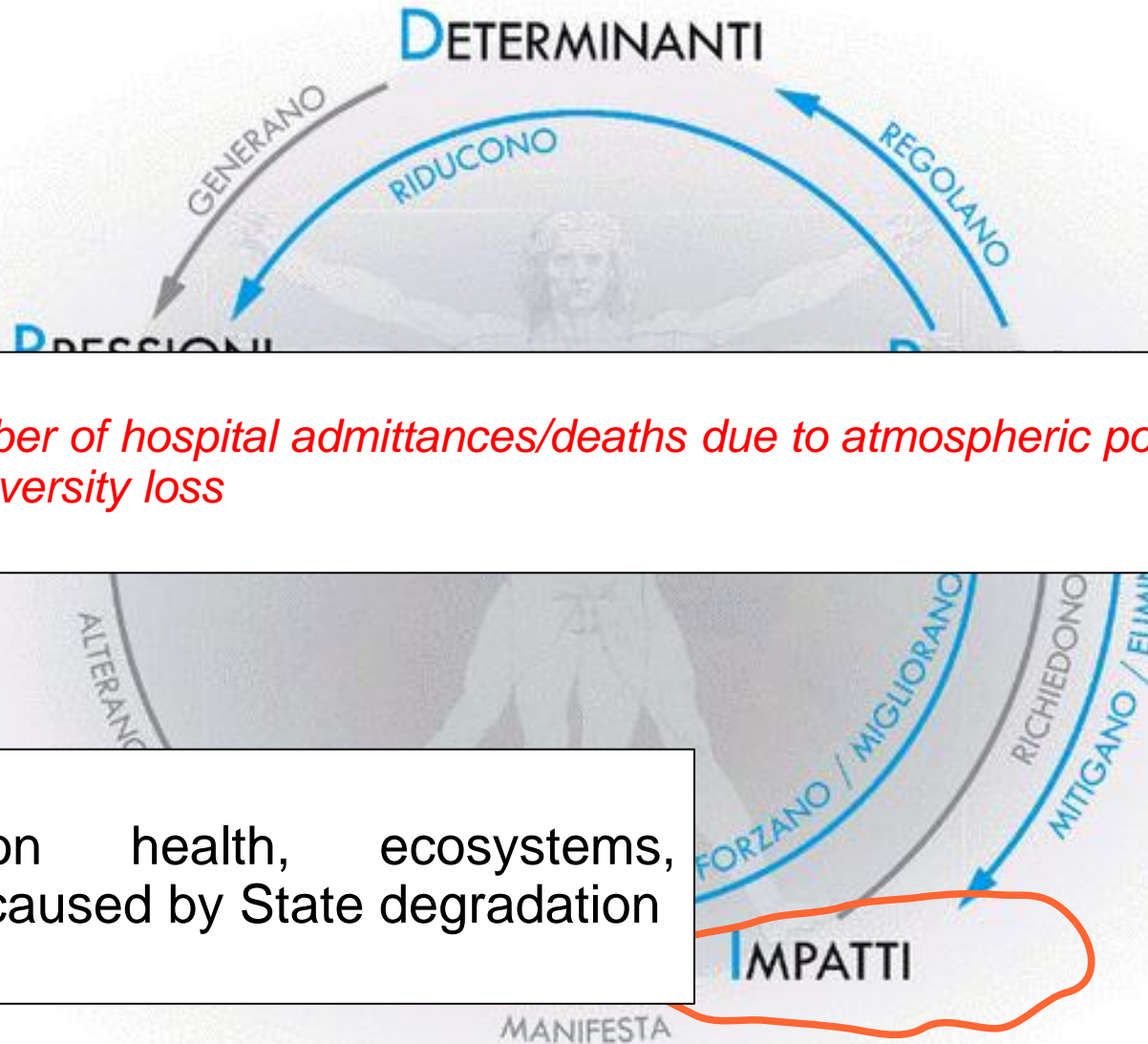

Es:

- 1. number of hospital admittances/deaths due to atmospheric pollution*
- 2. biodiversity loss*

...

IMPACTS:

effects on health, ecosystems, economy, caused by State degradation



in Air Quality terms...



D.P.S.I.R.

RESPONSES:
actions to reduce Impacts

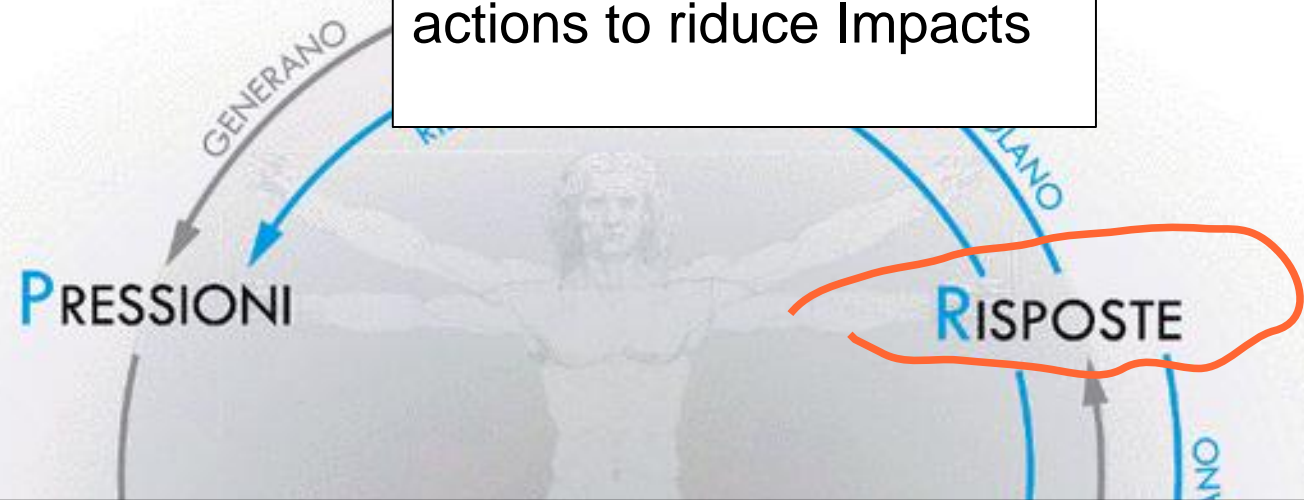

- Es:**
- *Legislation on Emissions and Air Quality*
 - *regional, national and european planning*
 - *limitations in authorizations*
 - *voluntary actions (Environmental Certification EMAS / ISO14001 -> Environmental Politics)*
 - *research and development*
 - *sustainable development models (information, good practices...)*
 - ...



D.P.S.I.R.

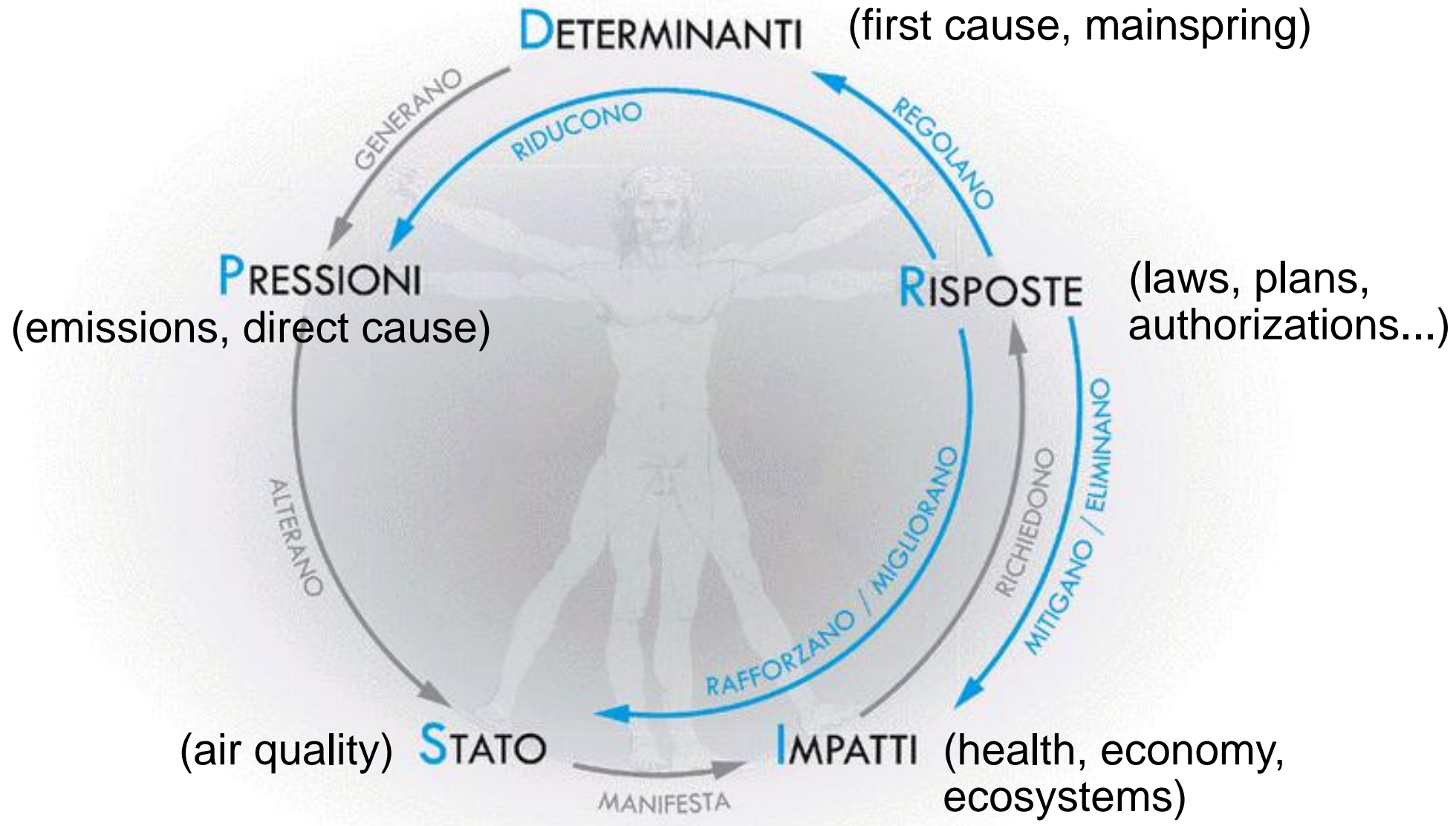



DPSIR: always valid...



DSPIR schema holds at every spatial and management scale:
global, national, regional... down to each single factory or activity

There is no use in trying to describe and manage atmospheric pollution phenomenon without considering all these elements.

... no use also in order to obtain an authorization!

Policy makers, Institutions responsible of environmental regulation, authorizations and planning, MUST keep in consideration ALL aspects of the phenomenon.

In Environmental Impact Evaluation, there is no use in describing the source (Pressure) alone.

Or, on the other hand, in measuring air quality (State) without correlating it with sources (Pressures).

We need MATHEMATICAL MODELS in order to make these relationships QUANTITATIVE.



DPSIR: always valid...



DSPIR schema holds at every spatial and management scale:
global, national, regional... down to each single factory or activity

There is no use in trying to describe and manage atmospheric pollution phenomenon without considering all these elements.

Institutions (Regional and local administrations, public agencies) are expected to provide/publish the following frameworks:

- *Driving Forces (Energy Plan, General Plan, meteorological data...)*
- *Pressures (Atmospheric Emissions Inventory)*
- *State (air quality monitoring network data, basin photochemical models)*
- *Responses (laws and regulations, Plans, authorizations)*

Environmental impact studies must refer to these informations.

These informations must be completed with specific ones, referring to the specific plant / infrastructure / Plan we are dealing with.

This rule holds in all the following cases:

- *Environmental Impact Assessment (it. VIA)*
- *Strategic Environmental Assessment (it. VAS)*
- *IPPC (it. AIA)*
- *authorizations released by provincial administration (it. AUA)*
- *authorization of plants for energy production from renewable sources*



We introduced:

D.P.S.I.R. schema

as a framework for the following elements and their **relations**:

1. **meteorology** = **DRIVING FORCE** (one of the Driving Forces)
2. pollution **sources** (emissions) = **PRESSURES**
3. outdoor **air quality** = **STATE**
4. its **effects** on health, ecosystems and economy = **IMPACTS**
5. **Legislation** and authorizations = **RESPONSES**

In most cases, Legislation allows us not to drive our analysis up to the determination of Impacts (on health and ecosystems): it gives us “ready-to-use” limit values to the pollutants concentration in ambient-air (State).

It means that impact analysis (risk analysis) has been already done, in order to define these limits. We refer to “criteria pollutants”.

If we are dealing with pollutants for which these limits are not defined (“non-criteria pollutants”, es: formaldehyde, dioxins...), Impacts evaluation (risk analysis) should be performed.



DPSIR And Mathematical Models



MATHEMATICAL MODELS

Why do we need them?

in order to describe and forecast atmospheric pollution, making DPSIR schema and relations quantitative ones.

Quantification: an attempt to give the best information to citizens and policy makers.

Forecast: impacts must be evaluated **BEFORE** a plant or an infrastructure is realized (Environmental Impact Assessment Study)

MATHEMATICAL MODELS

ANY QUANTITATIVE DESCRIPTION of the “atmospheric pollution” phenomenon and of the “relationships” between its “actors” IS A MATHEMATICAL MODEL.

It can be explicit or hidden. Simple or complex. Analytical or numeric. Lagrangian or eulerian...

I can go outdoor, measure the concentration of Nitrogen dioxide (NO₂) and say: “today in Codroipo we have 40 ug/m³”

I’ve just applied a mathematical model.

The simplest one: identity in time and space.

I stated that everywhere (in Codroipo) and everytime (today) the situation is the same.

It can be suitable or not, according to the “question” I must answer to.

Still I didn’t say anything about sources: where does NO₂ come from?

MATHEMATICAL MODELS

ANY QUANTITATIVE DESCRIPTION of the “atmospheric pollution” phenomenon and of the “relationships” between its “actors” IS A MATHEMATICAL MODEL.

It can be explicit or hidden. Simple or complex. Analytical or numeric. Lagrangian or eulerian...

If I say that NO₂ emissions from a heating plant are “negligible”, it means that:

- I quantified them (kg/year, mg/sec)*
- I applied some kind of rule... e.g. I verified that they're less than 5%, or 1%, or what else (I will write it down...), respect to the NO₂ emissions of a certain area*

But, at the end, we are interested to what happens to the air we breathe (State), not to the emissions by themselves (Pressure)

*When we say that an “emission is negligible” we omit some steps...
“if the source is negligible, its effects will be negligible as well...”*

In most cases, this approach will be considered admissible.

But... what, if the Zone where the emission takes place is ALREADY above the NO₂ limit value stated by Legislation (nonattainment area)?

Can a further worsening, even if “small”, still be considered admissible?

Models, DPSIR and authorizations

DRIVING FORCES (1):

- quantity of raw material
- number of workers
- hours of activity
- quantity of final product

...



Knowledge of the INDUSTRIAL PLANT:

allow to put DRIVING FORCES in relation with EMISSIONS (stack and fugitive), by means of **EMISSIONS FACTORS**

PRESSURES:

pollutants **MASS FLUX** [mass/time], NOT CONCENTRATION

[mass/volume].

SOURCE must be described by means of the parameters required by MODELS (area, height, emissions velocity and temperature, pollutants mass flux...)



Models

STATE:

air quality indexes in the area prone to plant emissions fall-out dell'impianto. STATE must be evaluated BEFORE and AFTER

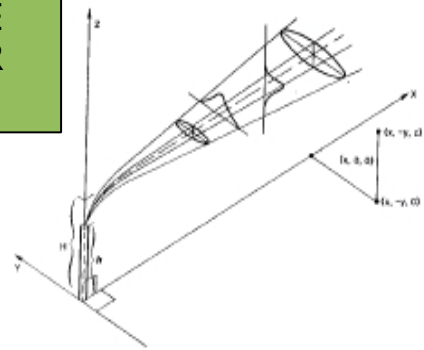
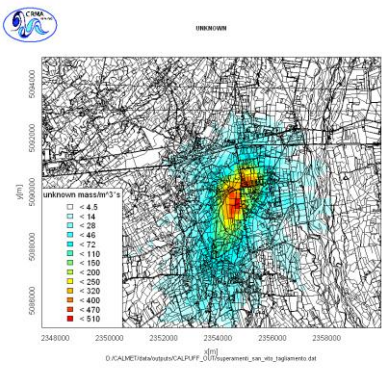

DRIVING FORCES (2):

models require some **meteorological** variables.

They must be given with adequate spatial and temporal resolution, and for an adequate time period and spatial domain.

Adequate for what? To define the effect on STATE (pollutants concentration in air)

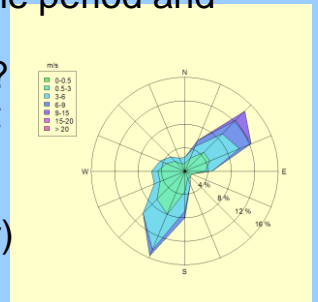

IMPACT:

for non-criteria pollutants or nonattainment areas, **RISK ANALYSIS...**

Models, DPSIR and authorizations: source description

DRIVING FORCES (1):

- quantity of raw material
- number of workers
- hours of activity
- quantity of final product
- ...



Knowledge of the INDUSTRIAL PLANT:

allow to put DRIVING FORCES in relation with EMISSIONS (stack and fugitive), by means of **EMISSIONS FACTORS**

PRESSURES:

pollutants **MASS FLUX**

[mass/time], NOT CONCENTRATION

[mass/volume].

SOURCE must be described by means of the parameters required by MODELS (area, height, emissions velocity and temperature, pollutants mass flux...)



Tipologia per suini in accrescimento:

Pavimento totalmente fessurato con vacuum system

◆ Fattore di emissione oggetto della ricerca:

Suini: 1.5 kg NH₃/posto x anno

14 kg CH₄/posto x anno

0.167 kg PM₁₀/posto x anno

http://www.agricoltura.regione.lombardia.it/shared/ccurl/769/330/AL_20090412_3674_relazione_conclusiva_AGR_MS.pdf

E.g.

A swine livestock emits 1.5 kg NH₃/year per head of cattle and 1000 heads of cattle are hosted...

This means:

$1000 \text{ [cattles]} * 1.5 \text{ [kg/year NH}_3\text{]} = 1.5 \text{ [t/year NH}_3\text{]}$

$1.5 \text{ [t/year]} / 8760 \text{ [hours/year]} = 0.17 \text{ [kg/h NH}_3\text{]}$

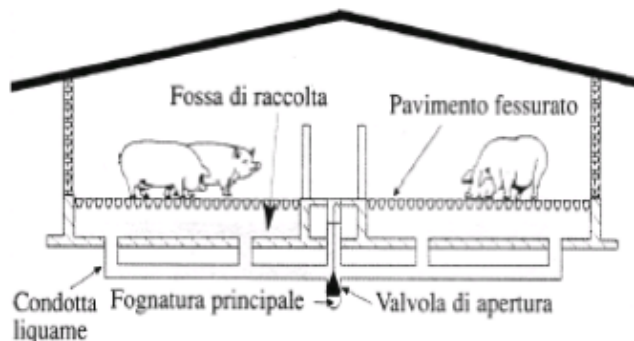

Later we will see HOW models use these informations...

Models, DPSIR and authorizations: source description

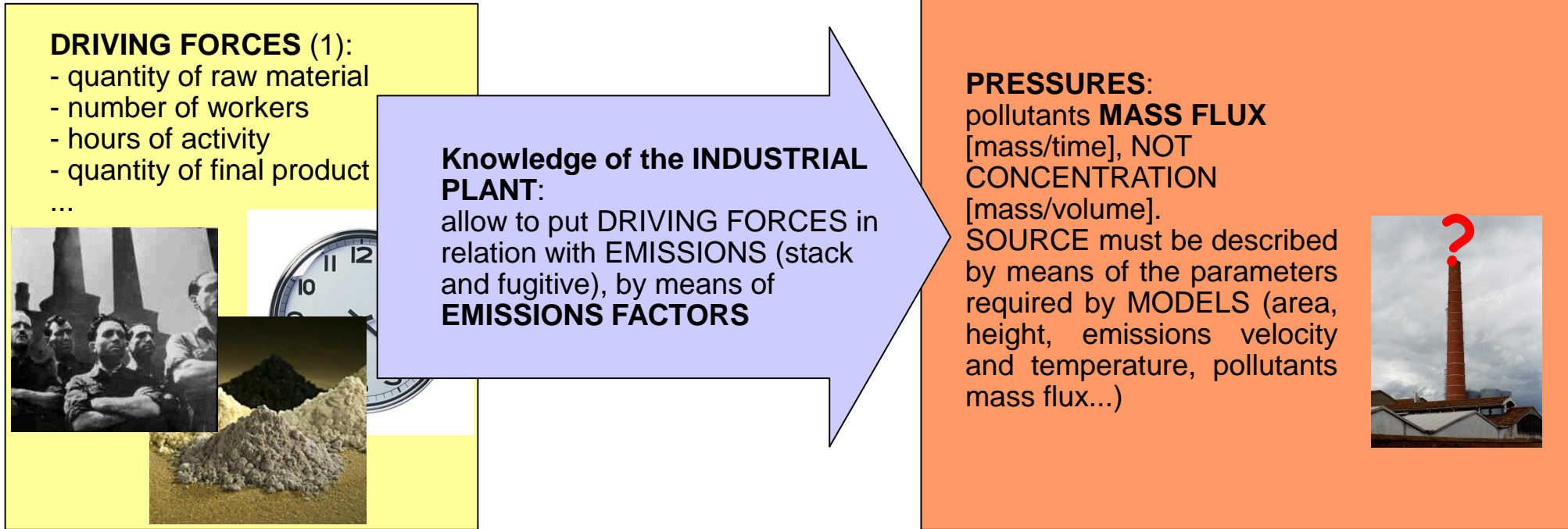

E.g.

An incineration plant emits ... NO₂ per hour and is in function for 8000 hours/year

A paint booth emits ... Toluene per painted chair and produces 600 chairs/day

A road...

Later we will see HOW models use these informations.

DPSIR schema...

... is a framework that holds **ALL** and **ONLY** the informations needed for an impact establishment.

To be avoided:

- *“steps skipping”*
- *“informations drowning” (DPSIR) in a tide of paper*

Mathematical models...

... differently from field **measures**, guarantee:

- **cause-effect** links quantitative interpretation (meteo, emissions, concentration in ambient-air, abatement systems... **DPSIR**)
- **prognosis** in space (area estimation instead of single points) and time (scenarios)

BUT... they are heavily ERROR PRONE!!



Example map - Ending

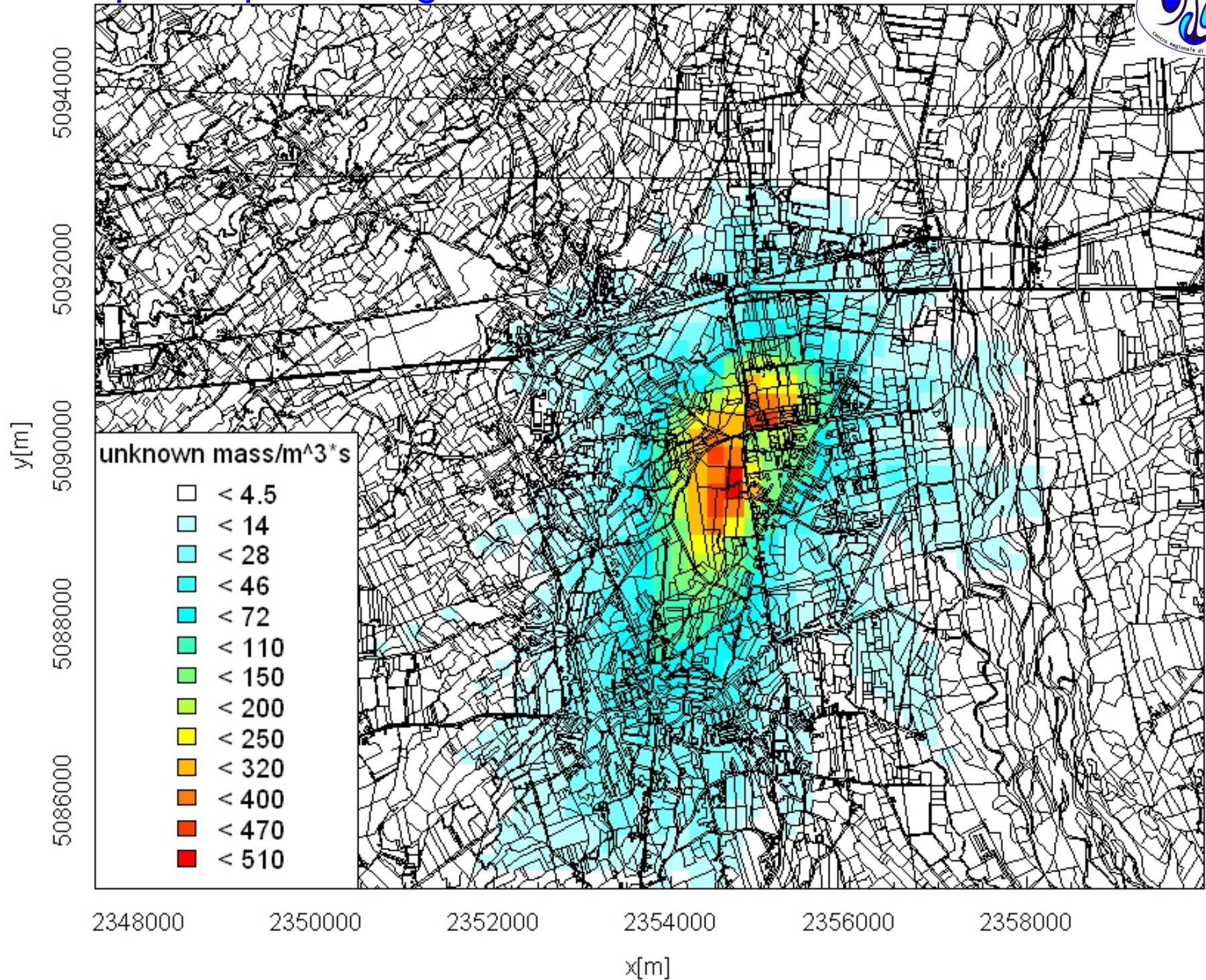

DPSIR schema...

1. *“The DPSIR framework used by the EEA”*, European Environment Agency, Kongens Nytorv 6, 1050 Copenhagen K, Denmark
http://root-devel.ew.eea.europa.eu/ia2dec/knowledge_base/Frameworks/doc101182/#

Mathematical models...

1. Roberto Sozzi, *“La Micrometeorologia e la Dispersione degli Inquinanti in Aria”*, APAT - CTN ACE, 2003
<http://www.arpalazio.net/main/aria/didattica/>
2. US EPA, *Technology Transfer Network - Support Center for Regulatory Atmospheric Modeling*
<http://www.epa.gov/scram001/>